



# Flohr Pools

## Pre- delivery Electrical Tips Vacanza Models

### Tip 1

- Get the written instructions from the Manufacturer, PLEASE pay close attention to these.
- Top manufacturers are very particular with electrical requirements. Even the same manufacturer often has different requirements from one model to the next.
- Check the serial number and verify you have the correct directions for your hot tub. If someone tells you all hot tubs are the same, be cautious.

### Tip 2

- Follow the NEC Code. Be advised that the Code calls for a disconnect within eyesight of the hot tub and may not be within 10 feet of the water.

### Tip 3

- Use an electrician that is licensed and follows manufacturers hot tub requirements. A contractor that is licensed is a good sign that you can rely on the work that they perform. When they ask for the manufacturer requirements this sets them apart from most in their field.

### Tip 4

- Your salesperson can make recommendations on licensed electricians in the area that are familiar with the electrical connections the model you have chosen requires. Please ask if you do not have an electrician that you are comfortable with.

### Tip 5

- All wiring outside the home, should be in conduit.

\*if there is a wiring issue upon start up of the spa (example the neutral and ground are not connected correctly) there will be a \$129 charge for Flohr Pools service department to make the correction.



## Vacanza® Series Pre-Delivery Instructions



CalderaSpas™

Please take the time to read this booklet carefully, as it will provide you with the information you will need to ensure the safe, secure, and timely installation of your new spa. The following sections are guidelines on how to prepare for delivery and set-up of your new spa. Specifically covered are site selection, delivery access, ground preparation, and electrical requirements.

Remember to carefully read the Owner's Manual that accompanies your spa, and to complete the warranty card within 10 days of delivery. These items, along with other valuable information, will be found in the Owner's Package which has been placed in the equipment compartment of your spa, where you will also find a serial number.

Watkins Manufacturing Corporation reserves the right to change features, specifications and design without notification and without incurring any obligation.

DATE PURCHASED: \_\_\_\_\_

DATE INSTALLED: \_\_\_\_\_

DEALER: \_\_\_\_\_

ADDRESS: \_\_\_\_\_

TELEPHONE: \_\_\_\_\_

In most cities and counties, permits will be required for the installation of electrical circuits or the construction of exterior surfaces (decks and gazebos). In addition, some communities have adopted residential barrier codes which may require fencing and/or self-closing gates on the property to prevent unsupervised access to a pool (or spa) by children under 6 years of age. Your Caldera® spa is equipped with a locking cover that meets the ASTM F1346-91 Standard for Safety Covers and as a result, is usually exempt from most barrier requirements. As a general practice, your local Building Department will inform you of any applicable barrier requirements at the time a permit is obtained for the installation of an electrical circuit. Your CALDERA dealer can provide information on which permits may be required.

# Pre-Delivery Instructions

## **SITE SELECTION AND PREPARATION**

**IMPORTANT:** Site selection and preparation are your responsibility. Carefully read these instructions and consult your authorized CALDERA dealer if you have any questions.

You probably have a spot picked out for your new spa, whether it's indoors or outdoors, on a patio or on a deck. Just make sure you check the following:

- Always put your spa on a structurally sound, level surface. A filled spa can weigh a great deal. Make certain that the location you choose can support the weight of your filled spa.
- Locate your equipment compartment, which houses all of the electrical components, in a place where water will drain away from it. Allowing water into the equipment compartment can damage the electronics, or may result in tripping your house's circuit breaker.
- Leave yourself easy access to the circuit breakers in the subpanel.
- Never let water get into the subpanel (230 volt models) or into the GFCI by the end of the power cord (115 volt models).
- Leave access to the entire front of the spa (the removable panel provides access to the spa's equipment) for periodic spa care and maintenance.

## **INDOOR/BASEMENT INSTALLATION**

Be aware of some special requirements if you place your spa indoors. Water will accumulate around the spa, so flooring materials must provide a good grip when wet. Proper drainage is essential to prevent a build-up of water around the spa. When building a new room for the spa, it is recommended that a floor drain be installed. The humidity will naturally increase with the spa installed. Water may get into woodwork and produce dryrot, mildew, or other problems. Check for the effects of airborne moisture on exposed wood, paper, etc. in the room. To minimize these effects, it is best to provide plenty of ventilation to the spa area. An architect can help to determine if more ventilation must be installed.

Your CALDERA dealer can help you with local information such as zoning regulations and building codes.

## **DECK INSTALLATION**

To be certain your deck can support your spa, you must know the deck's maximum load capacity. Consult a qualified building contractor or structural engineer before you place the spa on an elevated deck or indoors. To find the weight of your spa, its contents and occupants, refer to the Spa Specification chart on back page. This weight per square foot must not exceed the structure's rated capacity, or serious structural damage could result.

## **OUTDOOR AND PATIO INSTALLATION**

No matter where you install your new spa, it's important that you have a solid foundation to support it. Structural damage to the spa resulting from incorrect installation or placement on an inadequate foundation is not covered under the spa's limited warranty (See next page for specifics).

## GROUND AND SPA LEVELING PREPARATION

Your CALDERA spa has been engineered to perform on several types of common yard surfaces. While a concrete slab is best for long-term use\*, other foundations are acceptable so long as a level base is prepared prior to delivery. Three foundation base pictures, shown at right, represent examples of alternatives to a concrete slab for spas installed without gazebos or other accessories.

**\*NOTE:** A reinforced concrete pad at least four inches thick or structurally sound deck able to support the "dead weight" (found in the Spa Specification Chart on back page) is recommended for your CALDERA spa. The reinforcing rod or mesh in the pad should be attached to a bond wire.

### INSTALLATION NOTES:

- Concrete sloped at 1/2 inch per 10 feet is preferred so that rain water and water spillover will run off and not puddle underneath the spa (water under the spa for long periods of time may cause the wood to deteriorate).
- If stepping stones or railroad ties are selected for the spa foundation, they should be placed and leveled below the entire spa to maintain even distribution of the spa weight.
- It is important to note that soft surfaces, even when stepping stones are used to distribute the weight of the spa as evenly as possible, will still have a tendency to settle unevenly, resulting in an unlevel spa.
- Remember, placing the spa on grass or dirt may increase the amount of debris which is inadvertently brought into the spa water on the user's feet.

If you are purchasing a deck package or gazebo with your spa, a solid foundation becomes mandatory. Placing them on any surface other than a single level pad could create problems with their installation. Pictured at right are a few of the recommended surfaces.

As a homeowner, it is your responsibility to provide a suitable, level foundation for your spa. Keep in mind that most delivery crews are not equipped to level and prepare spa sites.

If you are interested in having a concrete slab, brick surface, or wood deck installed, your CALDERA dealer should be able to suggest a qualified, licensed contractor.

## DELIVERY ACCESS

First, locate the dimensions of your spa on the chart on the next page. The dimensions shown are the measurements of the spa in the vertical position, laid on its side.

Next, contact your dealer to find the height and width added by the delivery cart which the dealer will use to deliver your new spa. Use the height of the cart plus the dimension shown as H to determine the vertical clearance required to pass the spa and cart. Use the width of the cart, or dimension W, whichever is greater, to determine the maximum width of clearance necessary.

### FOUNDATIONS FOR SPAS ONLY (No accessories such as cover or gazebo)



PEA GRAVEL  
OR CRUSHED ROCK

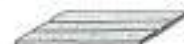

RAILROAD TIES



PRE-CAST  
STEPPING STONES

### FOUNDATIONS FOR SPAS WITH ACCESSORIES (such as gazebo)



CONCRETE PADS



BRICK SURFACES



WOOD DECKING

# Pre-Delivery Instructions

**NOTE:** It may be necessary to allow for additional over-head clearance if the spa will be rolled up or down an incline or moved up or down a short flight of stairs.

Use the information below to determine the requirements for access to your desired location. It may be necessary to remove a gate, part of a fence, or other movable obstructions in order to roll the spa to its installation site. About ten percent of the time, a crane is the only way to install the spa by lifting it to its final destination.

If the spa has to be taken off of the cart to go over a wall (either because the entry area is too narrow, the eaves are too low, the corner is too tight, or the stairway is too steep), a crane will be required. Don't be alarmed!

The crane has a truck-mounted boom which can fit right in your driveway. It is run by a licensed and insured operator. For a charge, the crane operator will lift your spa over walls, buildings, or any other obstruction and place it as close to the installation site as possible. The CALDERA spa delivery personnel will supervise the crane delivery and complete the spa placement. Crane delivery typically takes an average of 30 minutes to complete.

**NOTE:** If your spa delivery requires the use of a crane, you may be required to pay for its services at the completion of the delivery.



Model	Width W	Length L	Height H
Palatino®	38"	89"	89"
Marino®	36"	84"	84"
Vanto®	36"	84"	84"
Tarino™	33"	82"	82"
Averlino®	29"	64"	64"

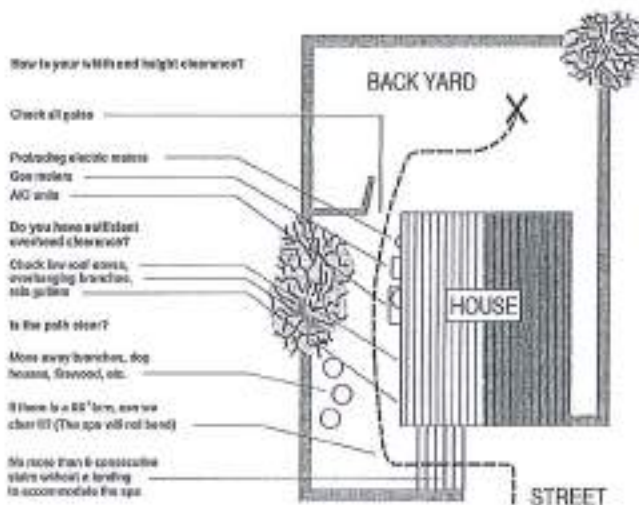

# PALATINO

*NOTE: All dimensions are approximate; measure your spa before making critical design or pathway decisions.*

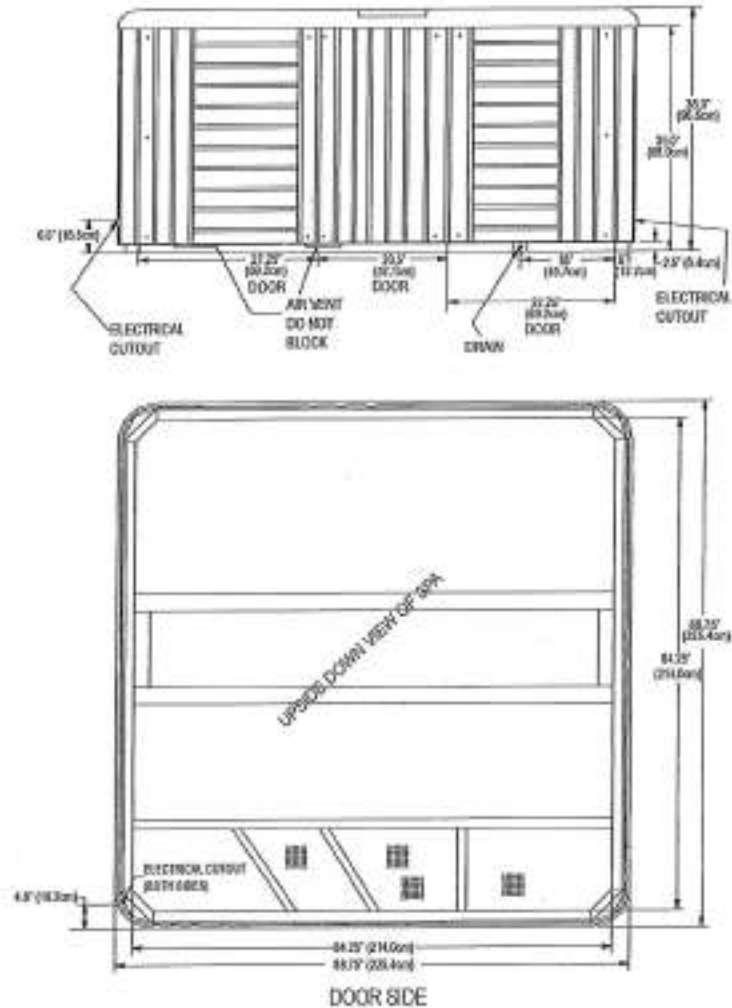

**NOTE:** Walkins Manufacturing Corporation recommends that the PALATINO be installed on a minimum 4" (10.2cm) thick reinforced concrete pad or structurally sound deck able to support the "dead weight" found in the spa specification chart.

**IMPORTANT:** The PALATINO must not be shimmed in any manner.

# Pre-Delivery Instructions

## MARINO / VANTO

*NOTE: All dimensions are approximate; measure your spa before making critical design or pathway decisions*

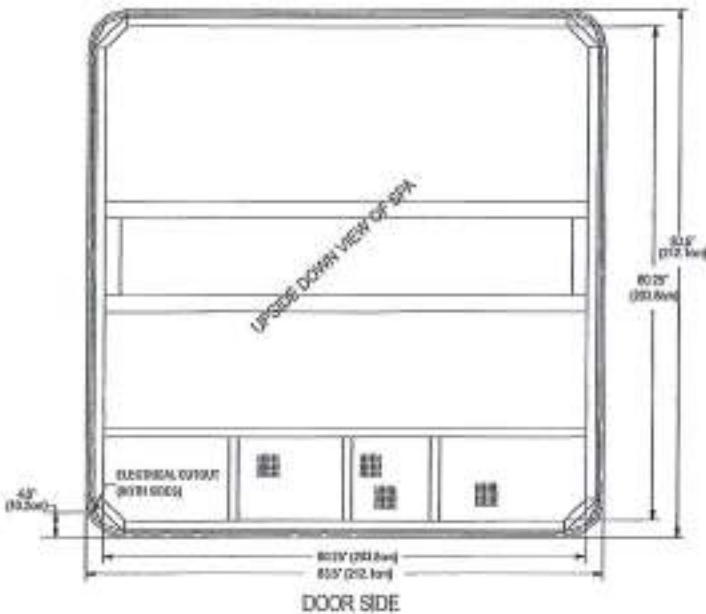
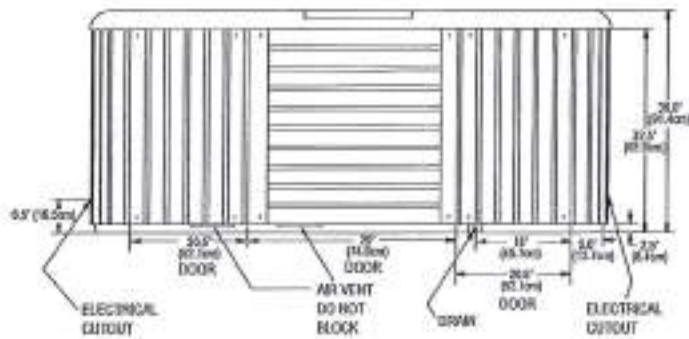

**NOTE:** Watkins Manufacturing Corporation recommends that the MARINO & VANTO be installed on a minimum 4" (10.2cm) thick reinforced concrete pad or structurally sound deck able to support the "dead weight" found in the spa specification chart.

**IMPORTANT:** The MARINO & VANTO must not be shimmed in any manner.



# TARINO

*NOTE: All dimensions are approximate; measure your spa before making critical design or pathway decisions.*

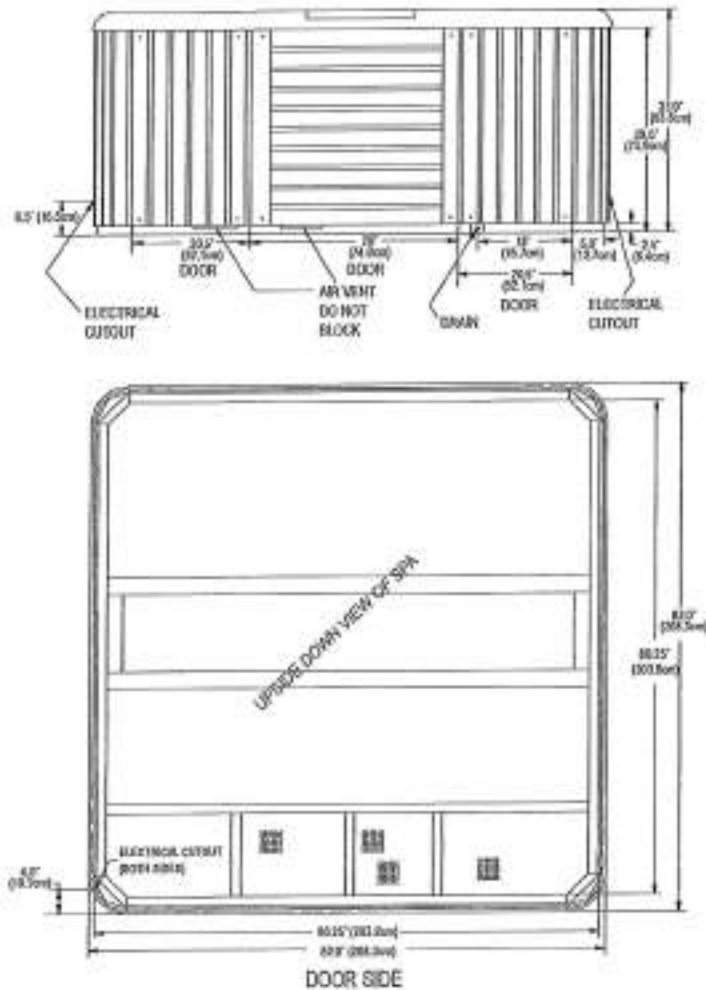

**NOTE:** Watkins Manufacturing Corporation recommends that the TARINO be installed on a minimum 4" (10.2cm) thick reinforced concrete pad or structurally sound deck able to support the "dead weight" found in the spa specification chart.

**IMPORTANT:** The TARINO must not be shimmed in any manner.

# Pre-Delivery Instructions

## AVENTINE

*NOTE: All dimensions are approximate; measure your spa before making critical design or pathway decisions.*

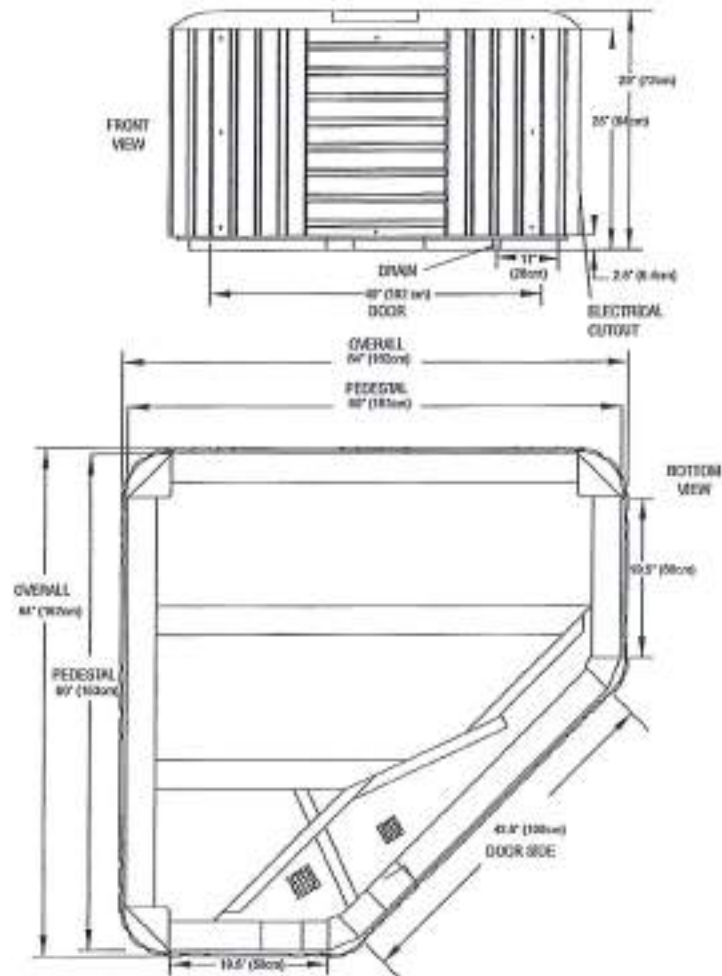

**NOTE:** Watkins Manufacturing Corporation recommends that the AVENTINE be installed on a minimum 4" (10.2cm) thick reinforced concrete pad or structurally sound deck able to support the "dead weight" found in the spa specification chart.

**IMPORTANT:** The AVENTINE must not be shimmed in any manner.

## ELECTRICAL REQUIREMENTS

### SELECTING THE VOLTAGE FOR YOUR SPA

The PALATINO, MARINO and VANTO models require a 230 volt power supply. The TARINO and AVENTINE may be converted from 115 volts to 230 volts. When the spa is connected to 115 volts, 20 amp, the heater will provide approximately 1000 watts of heat only when the pump is operating in LOW speed and the thermostat is calling for heat. When the TARINO or AVENTINE is connected to 230 volts, the heater will provide heat whether the pump is operating in LOW or HIGH speed and the thermostat is calling for heat.

All electrical connections must be made in accordance with the wiring information contained in the electrical control box or on the back of the field wiring access panel of the equipment module.

### STANDARD, CORD-CONNECTED 115 VOLT 20 AMP CONFIGURATION (TARINO & AVENTINE)

For your safety, if you are having an electrician install an electric outlet for the spa it should be no closer than 5 feet (152.4cm) and no further than 10 feet (304.8cm) from the spa. (Reference National Electrical Code 690 - 6a(1) and 680 - 41a.)

One GFCI is used in the cord-connected 20 amp configuration. The GFCI module is located at the end of the power cord. To test the GFCI, simply press the TEST button. The GFCI should trip to the "off" position, disconnecting power to the spa. To reset the GFCI, press the RESET button. The GFCI should reset, and power should be restored to the spa. If the GFCI does not function in this way, unplug the cord and contact an authorized CALDERA spa service technician.

**NOTE:** Consult your local code authority to determine if an electrical outlet with a cover is required for your installation. If it is, a suitable outlet cover may be purchased from your authorized CALDERA dealer.

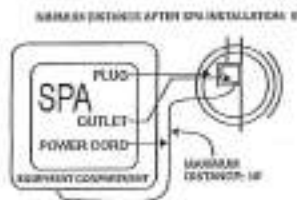

### 115 VOLT ELECTRICAL REQUIREMENTS

The TARINO & AVENTINE spa must be connected to a 115 volt, 20 amp grounded circuit. The equipment pack requires a MINIMUM of 112 volts under load. A dedicated circuit is required, the term "dedicated" means the electrical circuit CANNOT be used for any other high-load electrical items (patio lights, appliances, garage circuits, etc.). If the spa is connected to a non-dedicated circuit, overloading will result in "nuisance tripping" of the internal fuses or of the breaker switch at the house electrical breaker panel.

The circuit must be properly wired; that is, it must have the following:

- Standard (cord-connected) 115 volt 20 amp – A minimum 20 amp GFCI circuit breaker in the house panel, #12 AWG or larger wire (including the ground wire) and the correct polarity throughout the circuit.
- In addition to the dedicated 20 amp, 115 volt GFCI protected circuit, your spa requires a 20 amp single receptacle. This receptacle, which contains an outdoor-rated, weather-resistant receptacle cover plate, will be provided to you. The single receptacle and cover plate should be installed by your electrician prior to the delivery of your spa.

A pressure wire connector is provided on the exterior surface of the spa's electrical control box, located inside the equipment compartment. This is to permit the connection of a bonding ground wire between this point and any metal equipment, enclosures, pipe or conduit within five (5) feet of the spa (if needed to comply with local building code requirements). The bonding wire must be at least a #10 AWG solid copper wire.

**NEVER CONNECT THE SPA TO AN EXTENSION CORD!**

# Pre-Delivery Instructions

The TARINO and AVENTINE spa comes equipped with approximately 15 feet of usable power cord (this is the maximum length allowed by regulatory standards and the National Electric Code). The power cord is wrapped in bubble packaging for shipping and can be found inside the skirt. Remove the bubble wrap and roll the cord out to the desired length.

## 230 VOLT ELECTRICAL REQUIREMENTS

To ensure you will have an opportunity to use your spa soon after delivery, it is very important that the required electrical service has been installed. Unless otherwise stipulated by your dealer, **THIS IS YOUR RESPONSIBILITY.**

**IMPORTANT:** All electrical circuits must be installed by a qualified, licensed electrician. The equipment pack requires a **MINIMUM** of 112 volts per line under load.



## CAUTIONS

USE COPPER CONDUCTORS ONLY  
USE SUPPLY WIRES SUITABLE FOR 75°C/167°F.  
DISCONNECT ALL SUPPLY CONNECTIONS BEFORE SERVICING.  
CONNECT ONLY TO A CIRCUIT PROTECTED BY A CLASS A GROUND-FAULT INTERRUPTER.

THESE SPAS ARE INTENDED FOR USE WITH GFCI SUBPANEL  
ALL CANADIAN SPA MODELS USE #8 AWG GREEN, GROUND.  
INCORRECT WIRING WILL DAMAGE CIRCUIT BOARDS.  
REFER TO THE WIRING INSTRUCTIONS INCLUDED WITH THE SUB-PANEL FOR DETAILED WIRING INSTRUCTIONS.

## 230 VOLT INSTALLATION

Your spa contains a control box designed to operate at 230V, 60Hz. Installation of a 30 or 60 amp dedicated circuit is required. The control box must be hard wired directly to a subpanel protected by a Ground Fault Circuit Interrupter (GFCI). The subpanel containing the GFCI breaker is included with the PALATINO, MARINO and VANTO spas.

**IMPORTANT NOTE:** All electrical connections to the control box must be accomplished by a qualified electrician in accordance with the National Electrical Code and in accordance with any local electrical codes in effect at the time and place of installation.

All electrical connections must be made in accordance with the wiring information contained in this manual and on the back of the control box panel. A licensed electrician should install a four-wire electrical service (two line voltages, one neutral, one ground) from the main electrical service panel to the subpanel.

The grounding conductor must be at least #8 AWG. Your electrician should mount the subpanel in the vicinity of the spa but it should not be closer than five (5) feet from the spa water edge (NEC 680-38 to 41-A-3).

**INSTALLATION NOTE:** After the spa has been installed, your electrician can connect the conduit from the subpanel to the spa's control box and then complete the wiring connections in the control box.

**NOTE:** Complete step-by-step Installation and Wiring Instructions for all models are included in the Owner's Manual and with each subpanel, which can be obtained from your dealer.

**WARNING:** Removing or bypassing the GFCI breakers in the subpanel at any time will result in an unsafe spa and will void the warranty.

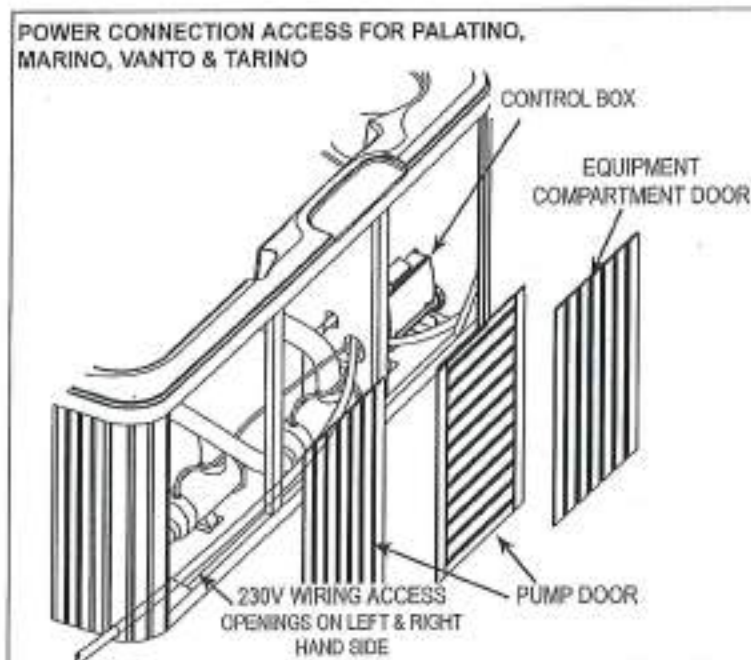

# Pre-Delivery Instructions

## SERVICES AVAILABLE FROM YOUR CALDERA DEALER

SERVICE	Cost
Pre-Delivery site inspection	_____
Deliver spa to installation site	_____
Unwrap spa and haul away packaging material	_____
Set up spa	_____
Fill the spa with water and add FROG® bromine and mineral cartridges	_____
Water quality and maintenance orientation	_____
Adjust the water's pH, Total Alkalinity and Calcium Hardness	_____
Sanitize the water	_____
Explain and test the spa's operation	
• Jet system	
• Air controls	
• Test lighting	
• Set temperature control	
• Control panel functions	
Explain the safety features	
• GFCI	
• Heater high limit	
General spa operation & maintenance orientation	_____
Inspect the spa cover, place on spa, and install cover locks	_____
Review winterizing instructions	_____
Review Owner's Manual & Warranty Card	_____
Follow-up call	_____
In-store spa water analysis	_____
<b>TOTAL COST</b>	

## ADDITIONAL PRODUCTS

- FROG bromine and mineral cartridges
- Monarch® CD ozone generator
- MONARCH water and spa care products
- Vinyl covers
- CALDERA Entertainment Systems
- Vanishing Act® Calcium Remover
- Clean Screen® Pre-Filter
- Replacement Filter Cartridge
- Pillows
- Retractable cover system with clearance requirements (PALATINO, MARINO, VANTO & TARINO spas only):

ProLIP® - 14" Clearance Required  
 PROLIFT II - 24" Clearance Required  
 PROLIFT III - 24" Clearance Required  
 PROLIFT IV - 7" Clearance Required



**NOTES**

# Pre-Delivery Instructions

## *NOTES*





**NOTES**

## VACANZA SPA SPECIFICATIONS

	Footprint dimensions	Height	Effective filter area	Heater (Watts)	Water capacity	Dry weight	Filled weight*	Dead weight*	Electrical requirements
<b>PALATINO</b> Seating (6 Adults)	88" x 88" 2.26m x 2.26m	38" .97m	85 Square feet 6m <sup>2</sup>	4,000	400 Gal- lons 1514 litres	911 lbs. 417 kg	5297 lbs. 2403 kg	120 lbs. per square foot	230 volt, 50 amp Single phase GFCI circuit
<b>MARINO</b> Seating (6 Adults)	84" x 84" 2.13m x 2.13m	36" .91m	85 Square feet 6m <sup>2</sup>	4,000	380 Gal- lons 1363 litres	836 lbs. 320 kg	4988 lbs. 2217 kg	120 lbs. per square foot	230 volt, 50 amp Single phase GFCI circuit
<b>VANTO</b> Seating (7 Adults)	84" x 84" 2.13m x 2.13m	38" .91m	85 Square feet 6m <sup>2</sup>	4,000	375 Gal- lons 1420 litres	847 lbs. 333 kg	5200 lbs. 2359 kg	125 lbs. per square foot	230 volt, 50 amp Single phase GFCI circuit
<b>TARINO</b> Seating (5 Adults)	82" x 82" 2.08m x 2.08m	33" .84m	30 Square feet 2.7m <sup>2</sup>	1,000 or 4,000	340 Gal- lons 1287 litres	705 lbs. 320 kg	4635 lbs. 2103 kg	115 lbs. per square foot	115 volt, 20 amp Dedicated GFCI protected cord or 230 volt, 50 amp Single phase GFCI circuit
<b>AVENTINE</b> Seating (2 Adults)	64" x 64" 1.63m x 1.63m	28" .74m	35 Square feet 3.2m <sup>2</sup>	1,000 or 4,000	150 Gal- lons 568 litres	501 lbs. 179 kg	2,102 lbs. 953 kg	105 lbs. per square foot	115 volt, 20 amp Dedicated GFCI protected cord or 230 volt, 50 amp Single phase GFCI circuit

**CAUTION:** Watkins Manufacturing Corporation suggests a structural engineer or contractor be consulted before the spa is placed on an elevated deck.

\* NOTE: The "Filled weight" and "Dead weight" of the spa includes the weight of the occupants (assuming an average occupant weight of 175 lbs).



CalderaSpas®

WATKINS MANUFACTURING CORPORATION

1280 Park Center Drive

Vista, California 92081

(800) 699-1881 ext:8000 8432

©2013 Watkins Manufacturing Corporation. Vacanza, Palatino, Marino, Vanto, Torino, Aventine, Caldera, Novarc, Veristone Act, Clean Screen, and ProLife are trademarks of Watkins Manufacturing Corporation. FROG is a registered trademark of King Technology, Inc.

Part #82908.14 Rev. A (11/13)